

*Betty 190x90*

PREDINSTALACIJA  
PREDINSTALACIJA  
PREINSTALLATION  
VORINSTALLATION

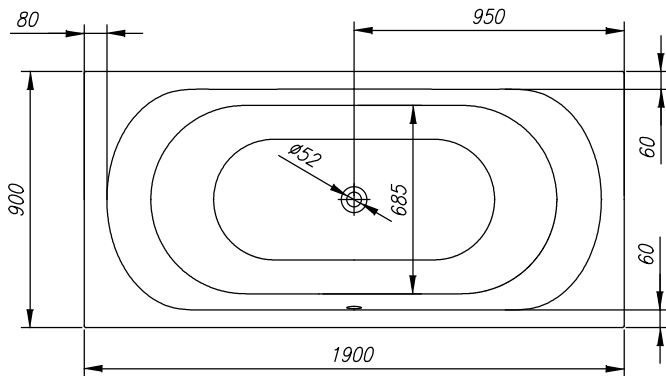
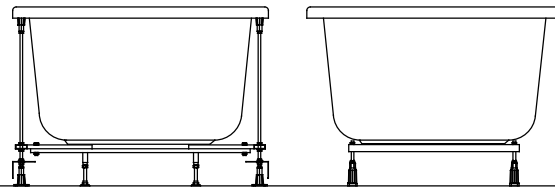
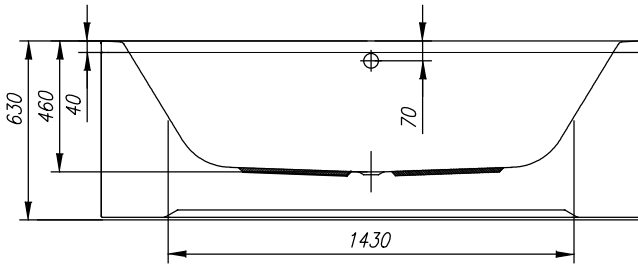

310 L

**VOLUMEN**  
**VOLUMEN**  
**VOLUME**  
**VOLUMEN**

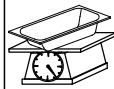

31 kg

**TEŽA**  
**TEŽINA**  
**WEIGHT**  
**GEWICHT**

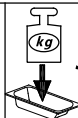

555 kg

**MAX. OBREMENITEV**  
**MAX. OBTEREČENJE**  
**MAX. LOAD**  
**MAX. BELASTUNG**

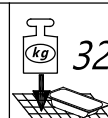

325 kg/m<sup>2</sup>

**OBREMENITEV TAL**  
**OBTEREČENJE PODA**  
**FLOOR LOAD**  
**BODENBELASTUNG**



- Prostor za električni vodnik 3x2,5 mm<sup>2</sup>, dolžine pribl. 1 m
- Mjesto za električni vodnik 3x2,5 mm<sup>2</sup>, dužine cca. 1 m
- Spot for electrical cable 3x2,5 mm<sup>2</sup>, length approx. 1 m
- Platz Stromkabel 3x2,5 mm<sup>2</sup>, Länge ungefähr 1 m



- Prostor za električni vodnik 1x6 mm<sup>2</sup> za ozemljitev, dolžine pribl. 1,5 m
- Mjesto za električni vodnik 1x6 mm<sup>2</sup> za ozemljenje, dužine cca. 1,5 m
- Spot for electrical cable 1x6 mm<sup>2</sup> for earthing, length approx. 1.5 m
- Platz Stromkabel 1x6 mm<sup>2</sup> für Erdung, Länge ungefähr 1,5 m



- Priklop tople in hladne vode 1/2", min 0,2 Mpa, max 0,4 Mpa
- Priključak tople i hladne vode 1/2", min 0,2 Mpa, max 0,4 Mpa
- Connection of hot and cold water 1/2", min 0.2Mpa, max 0.4Mpa
- Anschluss Warm- und Kaltwasser 1/2", min 0,2 Mpa, max 0,4 Mpa



- Prostor za odtok Ø 50 mm
- Mjesto za odtok Ø 50 mm
- Drain spot Ø 50mm
- Abflussplatz Ø 50 mm



- Opcija-obloga
- Opcija-obloga
- Panel - option
- Möglichkeit - Schürze

priporočilo za vgradnjo  
preporuka za ugradnju  
installation recommendation  
Einbauempfehlung

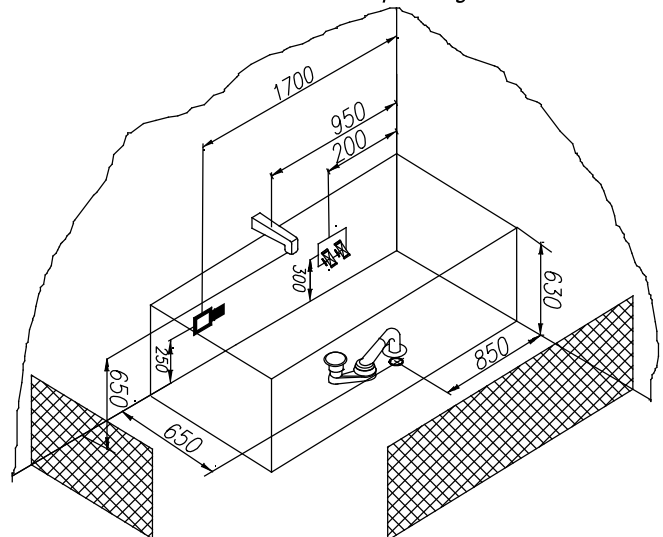

Priporočena prelivna garnitura  
Preporuka prelivne garniture  
Recommended overflow set  
Vorgeschlagene Überlaufgarnitur

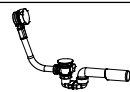

PAL 650

kopalna kad brez oblog - navodilo za vgradnjo  
Kada bez obloge - upute za ugradnju  
Bathtub without panel - installation instructions  
Badewanne ohne Schürze - Einbauanleitung

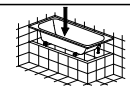

Nr. MK 03

Opcija podnožja za kadi brez obloge  
Varianta postolja za kade bez obloge  
Option of the built-in bathtub base  
Möglichkeit des Sockels für die Badewannen ohne Schürze



Nr. MK 05  
PKK 501

Kopalna kad z oblogo - navodilo za vgradnjo  
Kada s oblogom - upute za ugradnju  
Bathtub with panel - installation instructions  
Badewanne mit Schürze - Einbauanleitung

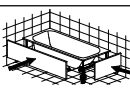

Nr. MK 01

Opcija podnožja za kadi z oblogo  
Varianta postolja za kade sa oblogom  
Option of the bathtub base with panel  
Möglichkeit des Sockels für die Badewannen mit Schürze

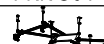

Nr. MK 13  
CM 180-200

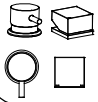

- MEŠALNI VENTIL TOPLA/HLADNA  
- VENTIL ZA MIEŠANJE TOPLO/HLADNO  
- MIXING VALVE HOT/COLD  
- MISCHVENTIL WARM/KALT



- PREKLOPNIK ROČNA PRHA/IZLIV  
- PREKIDAČ ZA RUČNI TUŠ/IZLJEV  
- HAND SHOWER/SPOUT SELECTOR SWITCH  
- SCHALTER FÜR HANDBRAUSE/AUSLAUF

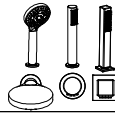

- ROČNA PRHA  
- RUČNI TUŠ  
- HAND SHOWER  
- HANDBRAUSE

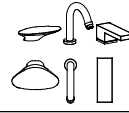

- IZLIV  
- IZLJEVNIK  
- SPOUT  
- AUSLAUF

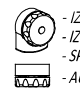

- IZLIV NA PRELIVNI GARNITURI  
- IZLJEV NA PRELJEVNOM SETU  
- SPOUT ON THE OVERFLOW SET  
- AUSLAUF AN DER ÜBERLAUFGARNITUR

- OPCIJA ENOROČNA ARMATURA WATERFALL
- OPCIJA JEDNORUČNA ARMATURA WATERFALL
- OPTION ONE HAND FITTING WATERFALL
- MÖGLICHKEIT EINWEG-ARMATUR WATERFALL

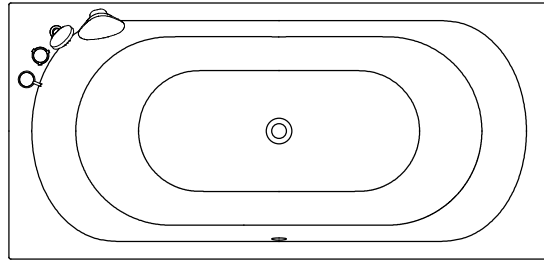
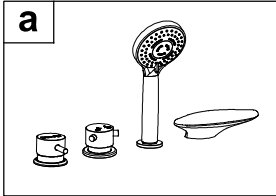

- OPCIJA ENOROČNA ARMATURA GEYSER
- OPCIJA JEDNORUČNA ARMATURA GEYSER
- OPTION ONE HAND FITTING GEYSER
- MÖGLICHKEIT EINWEG-ARMATUR GEYSER

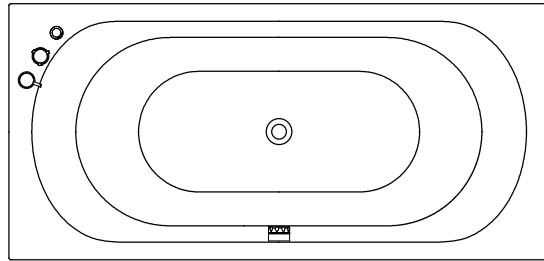
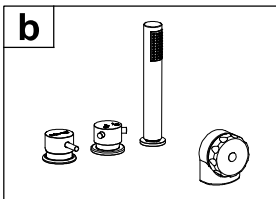

- OPCIJA ENOROČNA ARMATURA RAINDROP
- OPCIJA JEDNORUČNA ARMATURA RAINDROP
- OPTION ONE HAND FITTING RAINDROP
- MÖGLICHKEIT EINWEG-ARMATUR RAINDROP

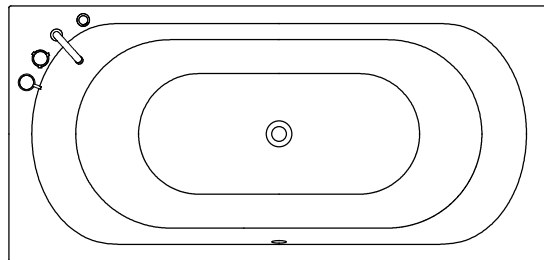
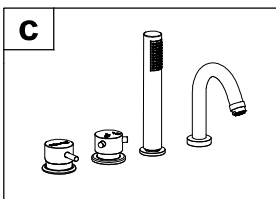

- OPCIJA ENOROČNA ARMATURA STREAM ( CHR / BLACK )
- OPCIJA JEDNORUČNA ARMATURA STREAM ( CHR / BLACK )
- OPTION ONE HAND FITTING STREAM ( CHR / BLACK )
- MÖGLICHKEIT EINWEG-ARMATUR STREAM ( CHR / BLACK )

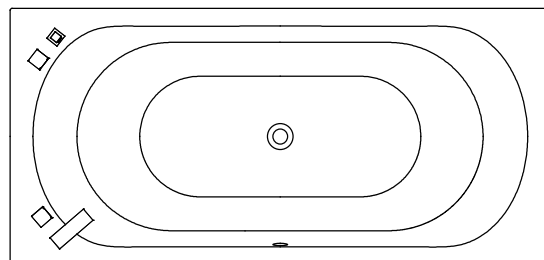
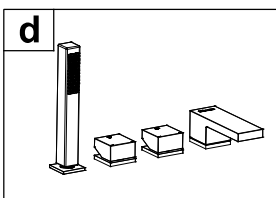

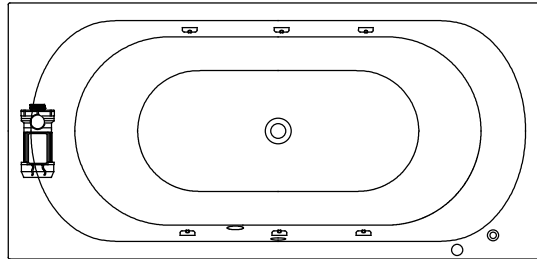
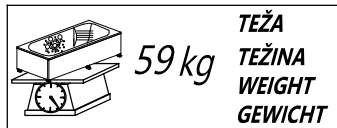
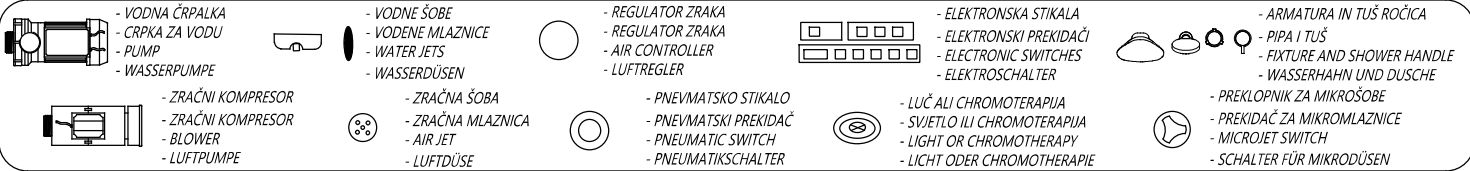

**VODNI MASAŽNI SISTEM 1**

- VODNA ČRPALKA P= 800W
- PNEVMATSKO STIKALO
- REGULATOR ZRAKA
- 6 VODNIH ŠOB

**VODENI MASAŽNI SISTEM 1**

- CRPKA ZA VODU P= 800W
- PNEVMATSKI PREKIDAČ
- REGULATOR ZRAKA
- 6 MLAZNICA ZA VODU

**WATER MASSAGE SYSTEM 1**

- PUMP P=800W
- PNEUMATIC SWITCH
- AIR CONTROLLER
- 6 WATER JETS

**WASSERMASSEGESYSTEM 1**

- WASSERPUMPE P = 800 W
- PNEUMATIKSCHALTER
- LUFTREGLER
- 6 WASSERDÜSEN

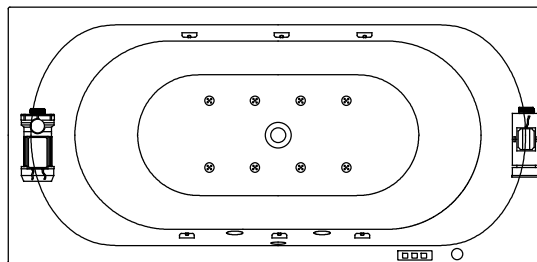
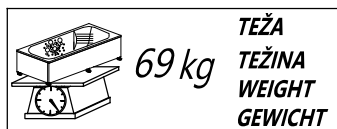

**VODNI IN ZRAČNI**  
**MASAŽNI SISTEM**

- VODNA ČRPALKA P= 800W
- ZRAČNI KOMPRESOR P=800W
- ELEKTRONSKO STIKALO
- 6 SUPER VODNIH ŠOB
- 8 ZRAČNIH ŠOB
- REGULATOR ZRAKA

**VODENI I ZRAČNI**  
**MASAŽNI SISTEM**







- CRPKA ZA VODU P= 800W
- ZRAČNI KOMPRESOR P=800W
- ELEKTRONSKI PREKIDAČ
- 6 SUPER MLAZNICA ZA VODU
- 8 ZRAČNIH MLAZNICA
- REGULATOR ZRAKA

**WATER AND AIR**  
**MASSAGE SYSTEM**

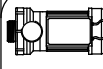
- PUMP P=800W
- BLOWER P=800W
- ELECTRONIC SWITCH
- 6 SUPER WATER JETS
- 8 AIR JETS
- AIR REGULATOR

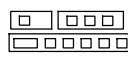
**WASSER UND LUFT**  
**MASSAGESYSTEM**

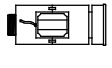
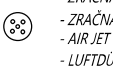
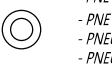
- WASSERPUMPE P = 800 W
- LUFTPUMPE P = 800 W
- ELEKTROSCHALTER
- 6 SUPER-WASSERDÜSEN
- 8 LUFTDÜSEN
- LUFTREGLER

- |  |  |   |   |  |
|--|--|---|---|--|
|  - VODNA ČRPALKA<br>- CRPKA ZA VODU<br>- PUMP<br>- WASSERPUMPE       |  - VODNE ŠOBE<br>- VODENE MLAZNICE<br>- WATER JETS<br>- WASSERDÜSEN |  - REGULATOR ZRAKA<br>- REGULATOR ZRAKA<br>- AIR CONTROLLER<br>- LUFTREGLER                |  - ELEKTRONSKA STIKALA<br>- ELEKTRONSKI PREKIDAČI<br>- ELECTRONIC SWITCHES<br>- ELEKTROSCHALTER                      |  - ARMATURA IN TUŠ ROČICA<br>- PIPA I TUŠ<br>- FIXTURE AND SHOWER HANDLE<br>- WASSERHAHN UND DUSCHE         |
|  - ZRAČNI KOMPRESOR<br>- ZRAČNI KOMPRESOR<br>- BLOWER<br>- LUFTPUMPE |  - ZRAČNA ŠOBA<br>- ZRAČNA MLAZNICA<br>- AIR JET<br>- LUFTDÜSE      |  - PNEVMATSKO STIKALO<br>- PNEVMATSKI PREKIDAČ<br>- PNEUMATIC SWITCH<br>- PNEUMATISCHALTER |  - LUČ ALI CHROMOTERAPIJA<br>- SVJETLO ILI CHROMOTERAPIJA<br>- LIGHT OR CHROMOTHERAPY<br>- LICHT ODER CHROMOTHERAPIE |  - PREKLOPNIK ZA MIKROŠOBE<br>- PREKIDAČ ZA MIKROMLAZNICE<br>- MICROJET SWITCH<br>- SCHALTER FÜR MIKRODÜSEN |

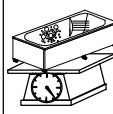
 **TEŽA**  
**TEŽINA**  
**WEIGHT**  
**GEWICHT**  
**80 kg**

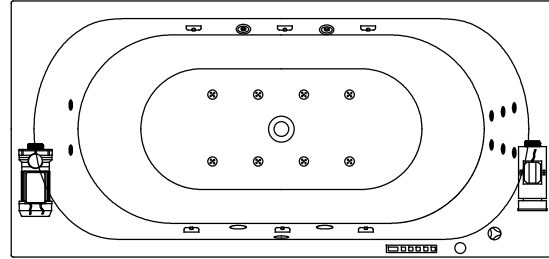





- VITAL MASAŽNI SISTEM**
- VODNA ČRPALKA P=1250W
  - ZRAČNI KOMPRESOR P=800W
  - GRELEC P=1500W
  - ELEKTRONSKO STIKALO
  - REGULATOR ZRAKA
  - 6 SUPER VODNIH ŠOB
  - 8 ZRAČNIH ŠOB
  - OZON ZA DEZINFEKCIJU
  - CHROMOTERAPIJA
  - 6 MIKROŠOB ZA HRBET
  - 2 MIKROŠOBI ZA NOGE

- VITAL MASAŽNI SISTEM**
- CRPKA ZA VODU P=1250W
  - ZRAČNI KOMPRESOR P=800W
  - GRUJAČ P=1500W
  - ELEKTRONSKI PREKIDAČ
  - REGULATOR ZRAKA
  - 6 SUPER VODNIH MLAZNICA
  - 8 ZRAČNIH MLAZNICA
  - OZON ZA DEZINFEKCIJU
  - CHROMOTERAPIJA
  - 6 MIKROMLAZNICA ZA LEDA
  - 2 MIKROMLAZNICE ZA NOGE

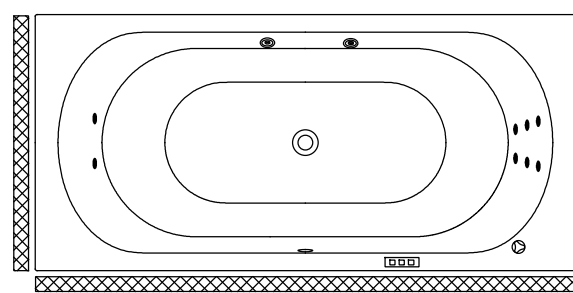

- VITAL MASSAGE SYSTEM**
- PUMP P=1250W
  - BLOWER P=800W
  - HEATER P=1500W
  - ELECTRONIC SWITCH
  - AIR CONTROLLER
  - 6 SUPER WATER JETS
  - 8 AIR JETS
  - OZONE FOR DISINFECTION
  - CHROMOTHERAPY
  - 6 MICROJETS FOR BACK
  - 2 MICROJETS FOR FEET

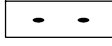

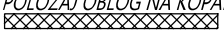
- VITAL MASSAGESYSTEM**
- WASSERPUMPE P = 1250 W
  - LUFTPUMPE P = 800 W
  - HEIZKÖRPER P = 1500 W
  - ELEKTROSCHALTER
  - LUFTREGLER
  - 6 SUPER WASSERDÜSEN
  - 8 LUFTDÜSEN
  - OZON FÜR DESINFEKTION
  - CHROMOTHERAPIE
  - 6 MIKRODÜSEN FÜR RÜCKEN
  - 2 MIKRODÜSEN FÜR FÜSSE

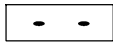
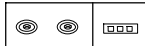
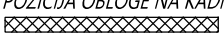

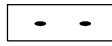
- OPCIJE**
- OPCIJA MIKROŠOBE 6 P=1250W  

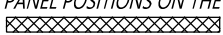
  - OPCIJA DVE DODATNI MIKRO ŠOBI  

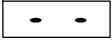
  - OPCIJA CHROMOTERAPIJA  

  - POLOŽAJ OBLOG NA KOPALNI KADI  

- OPCIJE**
- OPCIJA MIKROMLAZNICE 6 P=1250W  

  - OPCIJA DVIJE DODATNE MIKROMLAZNICE  

  - OPCIJA CHROMOTERAPIJA  

  - POZICIJA OBLOGE NA KADI  

- OPTIONS**
- OPTION 6 MICROJETS P=1250W  

  - OPTION TWO ADDITIONAL MICROJETS  

  - OPTION CHROMOTHERAPY  

  - PANEL POSITIONS ON THE BATH  

- MÖGLICHKEITEN**
- MÖGLICHKEIT MIKRODÜSEN 6 P = 1250 W  

  - MÖGLICHKEIT ZWEI ZUSÄTZLICHE MIKRODÜSEN  

  - MÖGLICHKEIT CHROMOTHERAPIE  

  - POSITION DER SHÜRZE FÜR BADEWANNE  
